



INSTRUCTIONS D'ASSEMBLAGE
ASSEMBLY INSTRUCTIONS

MONARCH
SPECIALTIES INC.

I 3203

**TABLE D'APPOINT -
NATUREL AVEC METAL CHROME**

**ACCENT TABLE -
NATURAL WITH CHROME METAL**



**POUR DE L'ASSISTANCE OU POUR COMMANDER
DES PIÈCES CONTACTEZ NOTRE DÉPARTEMENT
DE SERVICE À LA CLIENTÈLE.**

**FOR ASSISTANCE OR TO ORDER PARTS
CONTACT OUR CUSTOMER SERVICE DEPARTMENT**

WWW.MONARCHSERVICE.COM

LISTE DES PIÈCES
PARTS LIST

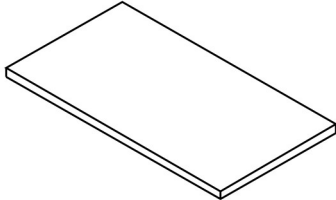
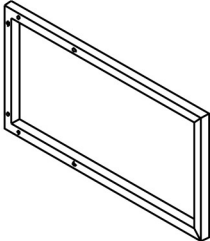
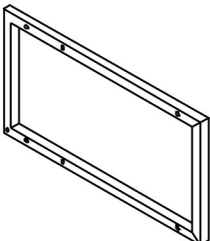
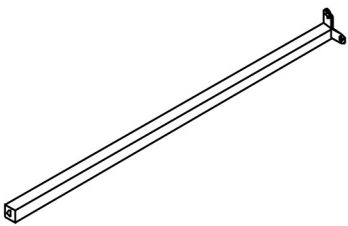
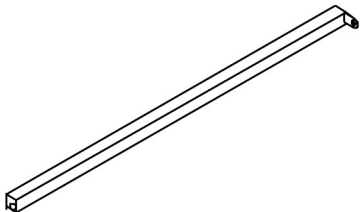
PIÈCE / PART #	IMAGE	DESCRIPTION	QTY / QTÉ
1		TABLE TOP SURFACE DE TABLE	1
2		TOP FRAME CADRE DE SURFACE	1
3		BOTTOM FRAME CADRE DU BAS	1
4		SUPPORT BAR BARRE DE SOUTIEN	2
5		SUPPORT BAR BARRE DE SOUTIEN	2

LISTE DES PIÈCES DE MONTAGE
HARDWARE LIST

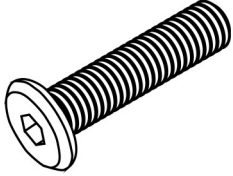
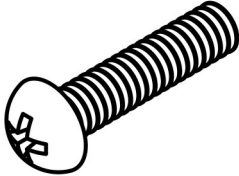
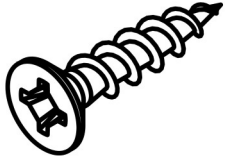
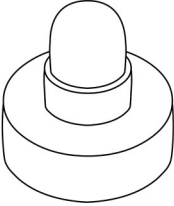
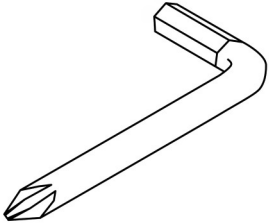
PIÈCE / PART #	IMAGE	DESCRIPTION	QTY / QTÉ
A		ASSEMBLING BOLT - Ø1/4" X 1 1/4" BOULON D'ASSEMBLAGE - Ø1/4" X 1 1/4"	4
B		ASSEMBLING BOLT - Ø1/8" X 1/2" BOULON D'ASSEMBLAGE - Ø1/8" X 1/2"	6
C		ASSEMBLING SCREW - 3/8" X 1 1/4" VIS D'ASSEMBLAGE - 3/8" X 1 1/4"	4
D		FLOOR PROTECTOR - 1/4" PROTECTEUR DE PLANCHER - 1/4"	4
E		HEX KEY CLÉ HEXAGONALE	1

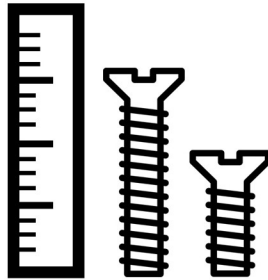

OUTIL DE VÉRIFICATION DE DIMENSIONS DES PIÈCES
HARDWARE DIMENSIONS VERIFICATION TOOL

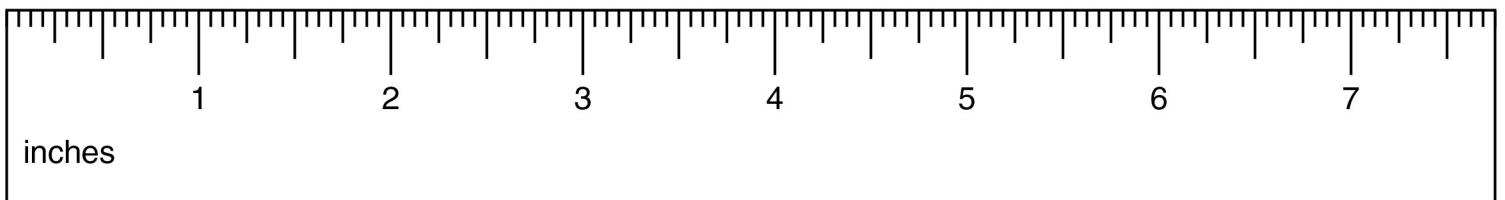

ÉTAPE / STEP 1

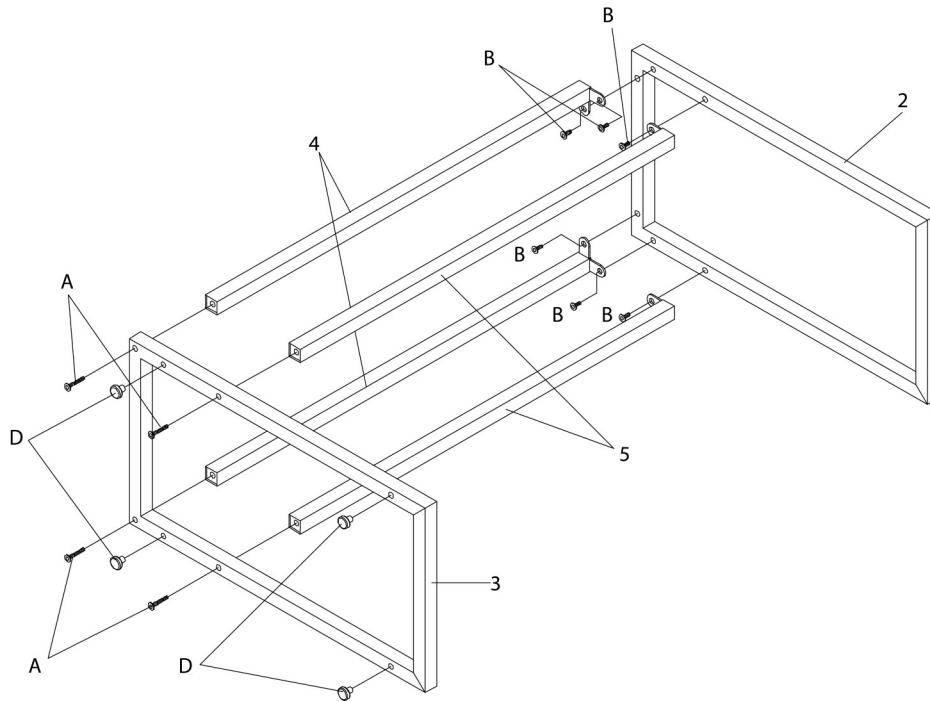

ÉTAPE / STEP 2

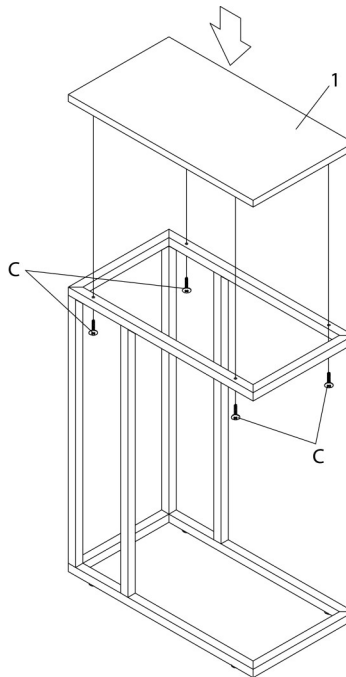

ÉTAPE / STEP 3

